

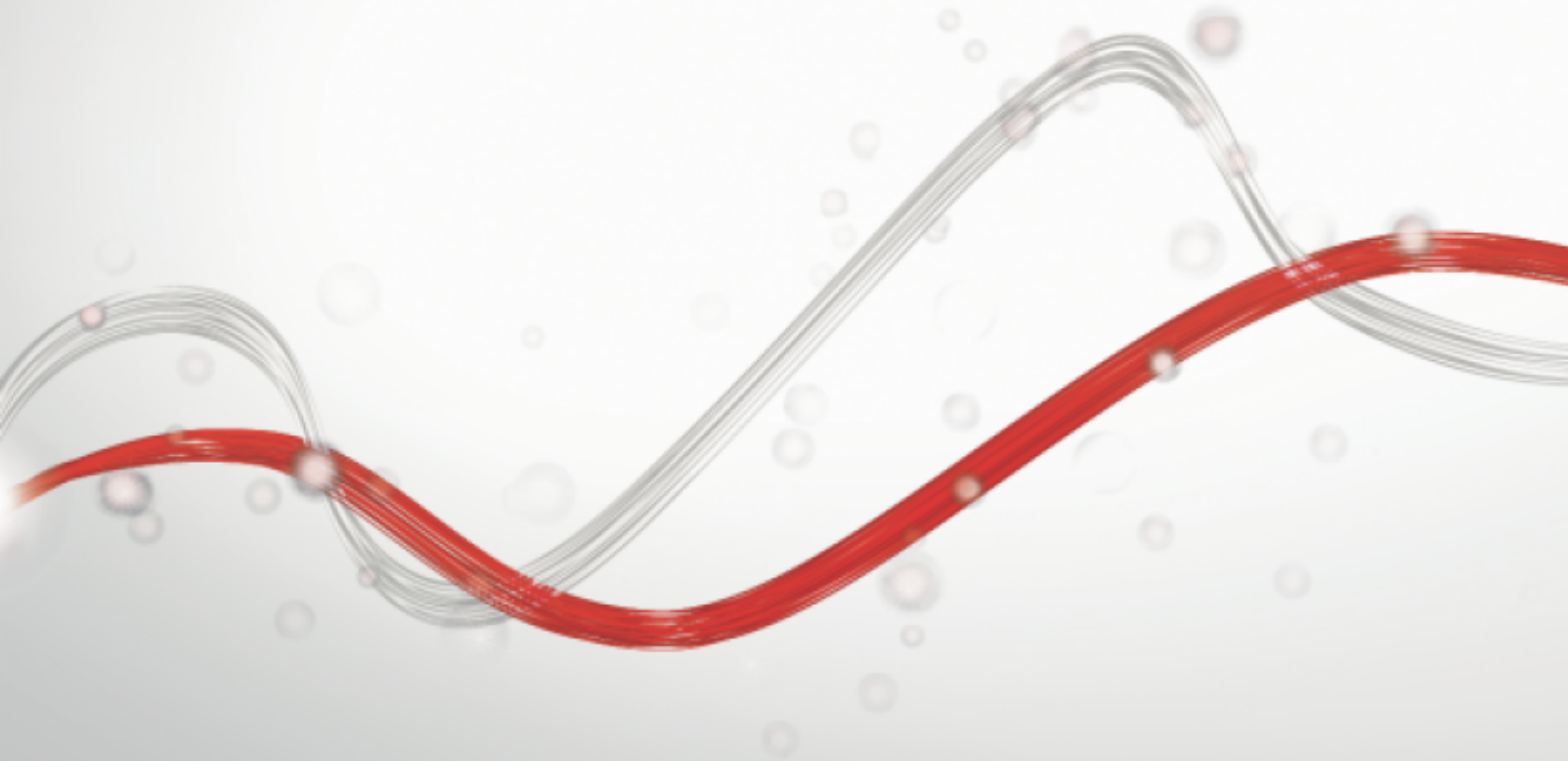

Be ahead

PILLAR B 275 / 600





Parking and traffic bollards

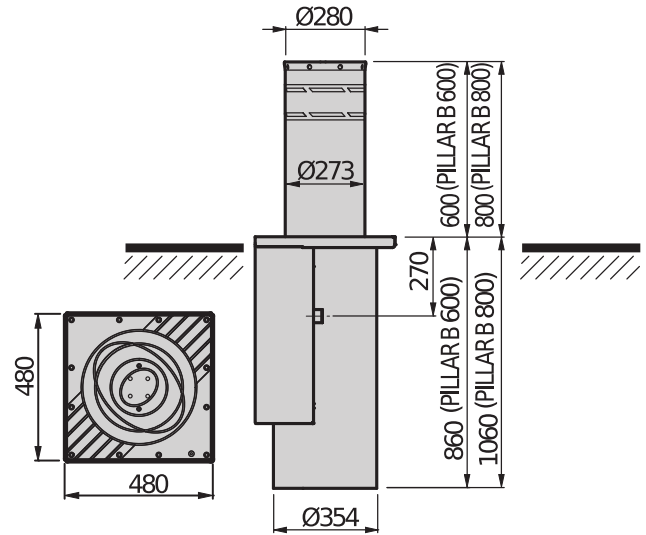

Anti-terrorist hydraulic bollard with incorporated hydraulic control unit. Suitable for protecting sensitive sites, thanks to the special "SD" version, which keeps the shaft raised in case of a power failure and with public installations where, in the standard version, the shaft lowers automatically with no power.





Parking and traffic bollards

PILLAR B 275 / 600

Code	Name	Description
P970092 00001	PILLAR B 275/600.6C L	230 V hydraulic bollard, shaft height 600 mm and diameter 273 mm. LED light cap and H adhesive strip: 100 mm, approved. The shaft automatically lowers in case of a power failure. Painted steel version, RAL 7015. Foundation box included. Cap with lights.
P970092 00101	PILLAR B 275/600.6C L - RAL	230 V hydraulic bollard, shaft height 600 mm and diameter 273 mm. LED light cap and H adhesive strip: 100 mm, approved. The shaft automatically lowers in case of a power failure. RAL colour to order. Foundation box included. Cap with lights.
P970092 00002	PILLAR B 275/600.6C LI	Hydraulic bollard 230 V, shaft height 600 mm and diameter 273 mm. LED light cap and H adhesive strip: 100 mm approved. The shaft automatically lowers in case of a power failure. Stainless steel version. Cap with lights, stainless steel version.
P970092 00003	PILLAR B 275/600.6C L SD	Hydraulic bollard 230 V, shaft height 600 mm and diameter 273 mm. LED light cap and H adhesive strip: 100 mm approved. The shaft stays raised in case of a power failure. RAL 7015 painted steel version. Security & Device version.
P970092 00103	PILLAR B 275/600.6C L SD - RAL	230 V hydraulic bollard, shaft height 600 mm and diameter 273 mm. LED light cap and H adhesive strip: 100 mm, approved. The shaft remains in the raised position in case of a power failure. Painted steel version, RAL colour to order. Foundation box included. Security & Device version.
P970092 00004	PILLAR B 275/600.6C LI SD	Hydraulic bollard 230 V, shaft height 600 mm and diameter 273 mm. LED light cap and H adhesive strip: 100 mm approved. The shaft stays raised in case of a power failure. Stainless steel version. Security & Device version.

PERSEO CBE 230.P SD: Control unit with U-Link, receiver and incorporated heating circuit (to -40°C) for electro-mechanical and hydraulic bollards. Can manage up to 4 bollards at the same time (or up to 2 Xpass 1200)



D113812 00002 - PERSEO CBE 230.P SD - Recommended



- Control unit with U-Link, receiver and incorporated heating circuit (to -40°C) for electro-mechanical and hydraulic bollards. Can manage up to 4 bollards at the same time (or up to 2 Xpass 1200)
- Application: Control panel for operating 1 to 4 automatic bollards, single-phase (in parallel) (or max. 2 XPASS B 330/1200)
- Board power supply: 230V single phase
- Output power: 230Vac single-phase, 12A max.
- Main features: removable terminal blocks, digital programming, 3-digit display, Proxima programmer connector, dual-channel receiver 2048 codes included, heater for operation to -40°C, complete support for anti-terrorism bollards, 11 inputs, 9 outputs.
- Main features: U-Link interconnectivity, automatic reclosing, separate open and close, pre-flashing, deadman control, automatic or semi-automatic, opening and closing limit switch management, arranged for UPS.

	PILLAR B 275/600.6C L	PILLAR B 275/600.6C L - RAL	PILLAR B 275/600.6C LI	PILLAR B 275/600.6C L SD	PILLAR B 275/600.6C L SD - RAL	PILLAR B 275/600.6C LI SD
Control unit	PERSEO CBE 230.P SD	PERSEO CBE 230.P SD	PERSEO CBE 230.P SD	PERSEO CBE 230.P SD	PERSEO CBE 230.P SD	PERSEO CBE 230.P SD
Power supply	230 V	230 V	230 V	230 V	230 V	230 V
Opening or closing time	5 s	5 s	5 s	5 s	5 s	5 s
Rod height	600 mm	600 mm	600 mm	600 mm	600 mm	600 mm
Rod thickness	6 mm	6 mm	6 mm	6 mm	6 mm	6 mm
Rod diameter	273 mm	273 mm	273 mm	273 mm	273 mm	273 mm
Type of limit switch	REED magnetic sensor	REED magnetic sensor	REED magnetic sensor	REED magnetic sensor	REED magnetic sensor	REED magnetic sensor
Slowdown	no	no	no	no	no	no
Impact resistance	20000 J	20000 J	20000 J	20000 J	20000 J	20000 J
Break-in proof	250000 J	250000 J	250000 J	250000 J	250000 J	250000 J
Manual cycle	reversible in the absence of voltage	reversible in the absence of voltage	reversible in the absence of voltage	Release key	Release key	Release key















PILLAR B 275 / 600



Parking and traffic bollards

	PILLAR B 275/600.6C L	PILLAR B 275/600.6C L - RAL	PILLAR B 275/600.6C LI	PILLAR B 275/600.6C L SD	PILLAR B 275/600.6C L SD - RAL	PILLAR B 275/600.6C LI SD
Frequency of use	3000 Op/gg	3000 Op/gg	3000 Op/gg	3000 Op/gg	3000 Op/gg	3000 Op/gg
Protection rating	IP67	IP67	IP67	IP67	IP67	IP67
Environmental conditions	-40 ÷ 60 °C	-40 ÷ 60 °C	-40 ÷ 60 °C	-40 ÷ 60 °C	-40 ÷ 60 °C	-40 ÷ 60 °C

RECOMMENDED ACCESSORIES

	P800116 - TOTEM UNIT Base module for TOTEM, can be used for both lower and upper units.		new P800116 00102 - TOTEM UNIT - RAL Base module for TOTEM, can be used for both lower and upper units. RAL colour as requested.
	P800117 - TLIGHTS Traffic lights and top covering for totem		P800117 00102 - TLIGHTS - RAL Traffic lights and upper cover for totem unit. RAL colour to order
	P800102 - PILLAR ALARM Magnetic anti-theft kit for PILLAR B hydraulic bollards. To be requested when ordering		P800040 - TPF Foundation and anchor plate for totem
	P800108 - TCAP Top covering without lights for elements of Totem.		P800108 00102 - TCAP - RAL Top covering without lights for elements of Totem. RAL colour as requested.
	D113705 - ACOUSTIC DETECTOR Adjustable acoustic detector for sirens		P111001 00003 - RME 2 230 V dual channel metal object detector with installation base
	D110926 00001 - SPIRA 2X1 Magnetic loop 2 x 1 m		P800114 - BOLLARD CABLE EXT25 Extra charge for 25 m cable for bollards (to be added to the 10 included into bollards)
	P800115 - BOLLARD CABLE EXT50 Extra charge for 50 m cable for bollards (to be added to the 10 included into bollards)		

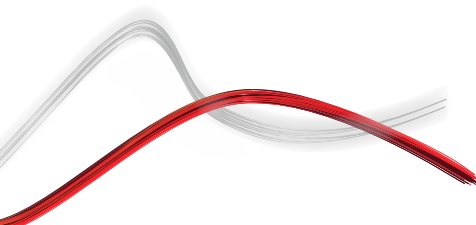



Parking and traffic bollards

What is U-Link?

The technology that gives you more power

U-Link, Universal Link, is an exclusive BFT platform that can be used to create high-tech ecosystems. In Home Access Automation, it can be used to communicate with all home access automation devices of any brand. This saves you time and allows you to control everything easily and without any worries.

It is intuitive

Easy to install and to use

It is scalable

You can add as many devices as you want

It is flexible

It allows you to create groups of interconnected products

It is practical

Works with or without an internet connection

It is functional

Its settings can be controlled remotely using dedicated applications



Parking and traffic bollards

Everything on one screen: find out more about this amazing technology

A world-exclusive platform that **can be used to create high-tech ecosystems** offering a vast range of solutions for many different sectors.

This proprietary platform which is a key feature of BFT products, thanks to the B-EBA cards and the Clonix U-Link receiver, is suitable for any protocol or product for access automation (including BFT products non-BFT ones and older versions) and it can be used in a variety of different sectors. This means any device becomes a smart device which can be interconnected with other systems, using a language that is becoming universal.



U-Control HOME

U-Control HOME is the application that allows you to open the gate to your home and to remotely control BFT automations using your own smartphone. The iOS version can be used to automatically open the automation when you are close to it.



U-Base 2

A software package for installation, performing maintenance and identifying any faults in the U-Link compatible operators, easily and conveniently.



U-SDK

U-SDK is the application which allows BFT automations to be made compatible and easily integrated with a BMS network.



Clonix U-Link

Connect non-native U-Link and non-BFT products to U-Link systems.

Is it possible to connect non-native U-Link BFT operators or other brands of products to U-Link? Yes, thanks to the Clonix receivers. Accessories which accept no limits.



B-EBA

A direct link to your operators.

The B-EBA expansion cards make it possible to connect external devices such as PCs, smartphones and tablets to a BFT operator and a Clonix receiver or to connect multiple BFT products in a U-Link network. These accessories integrate with U-Link technology and with Bluetooth, Wifi, Z-Wave and TCP/IP protocols as well as with the RS485 serial interface. A device that demonstrates exactly what BFT means by interconnectivity.

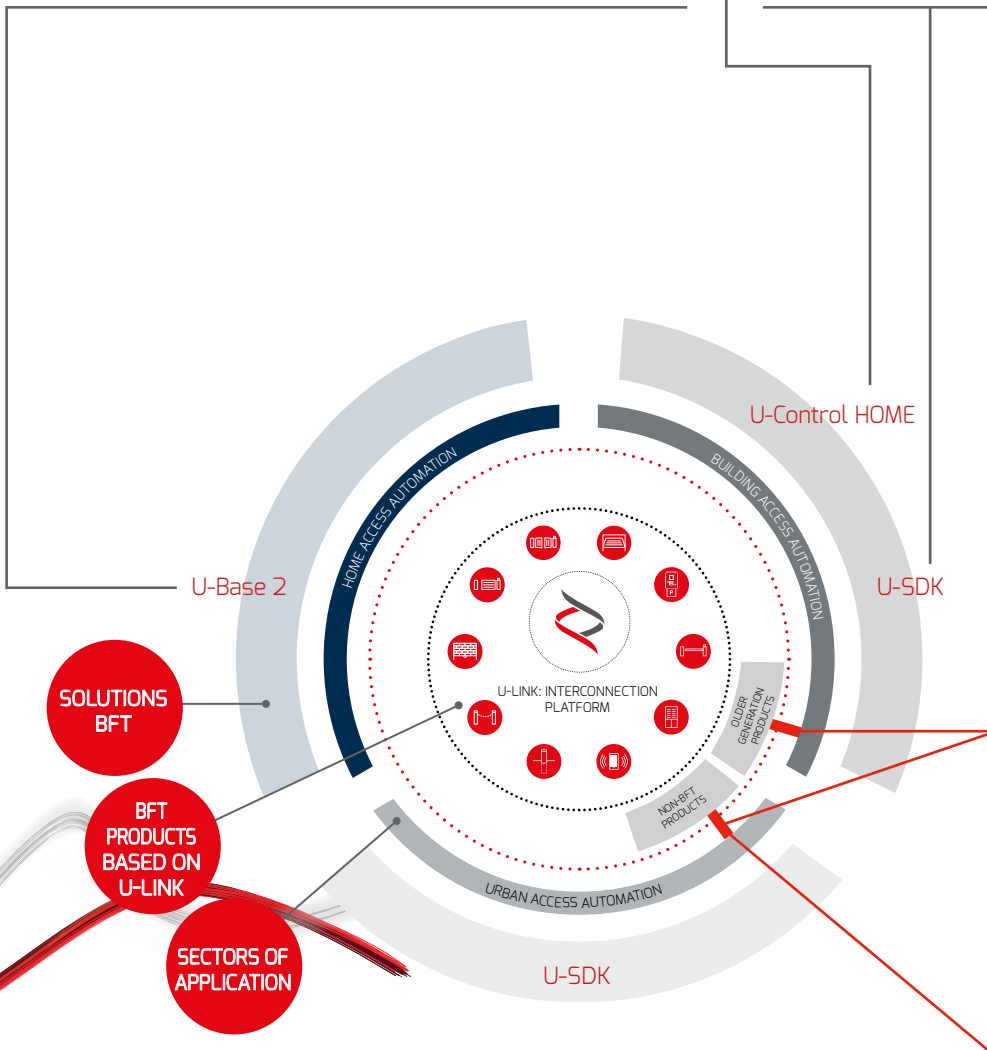



INFORMATION REGARDING THE PROTECTION OF THE INDUSTRIAL AND INTELLECTUAL PROPERTY RIGHTS OF BFT. BFT S.p.A. protects its industrial property by depositing trademarks, patents, models and designs. The intellectual property of BFT S.p.A. is protected by copyright law. BFT S.p.A. also protects its know-how by taking measures to protect the technical and commercial information inherent in its company and products. All the products in this catalogue are ORIGINAL BFT MODELS and only BFT S.p.A. is authorised to produce them and market them anywhere in the world. All the commercial names in this catalogue are owned by BFT S.p.A., and only BFT S.p.A. is authorised to use them in relation to the corresponding merchandise category. FALSIFIERS WILL BE PROCEEDED AGAINST IN ACCORDANCE WITH BOTH CIVIL AND CRIMINAL LAW. THESE CONDITIONS NOT ONLY GUARANTEE THE INTELLECTUAL PROPERTY RIGHTS OF BFT, BUT ALSO PROTECT CUSTOMERS BY GUARANTEEING THAT THE PRODUCTS THEY ARE PURCHASING ARE ORIGINAL BFT PRODUCTS RESULTING FROM STUDIES AND DESIGNS WITHIN THE BFT COMPANY.