

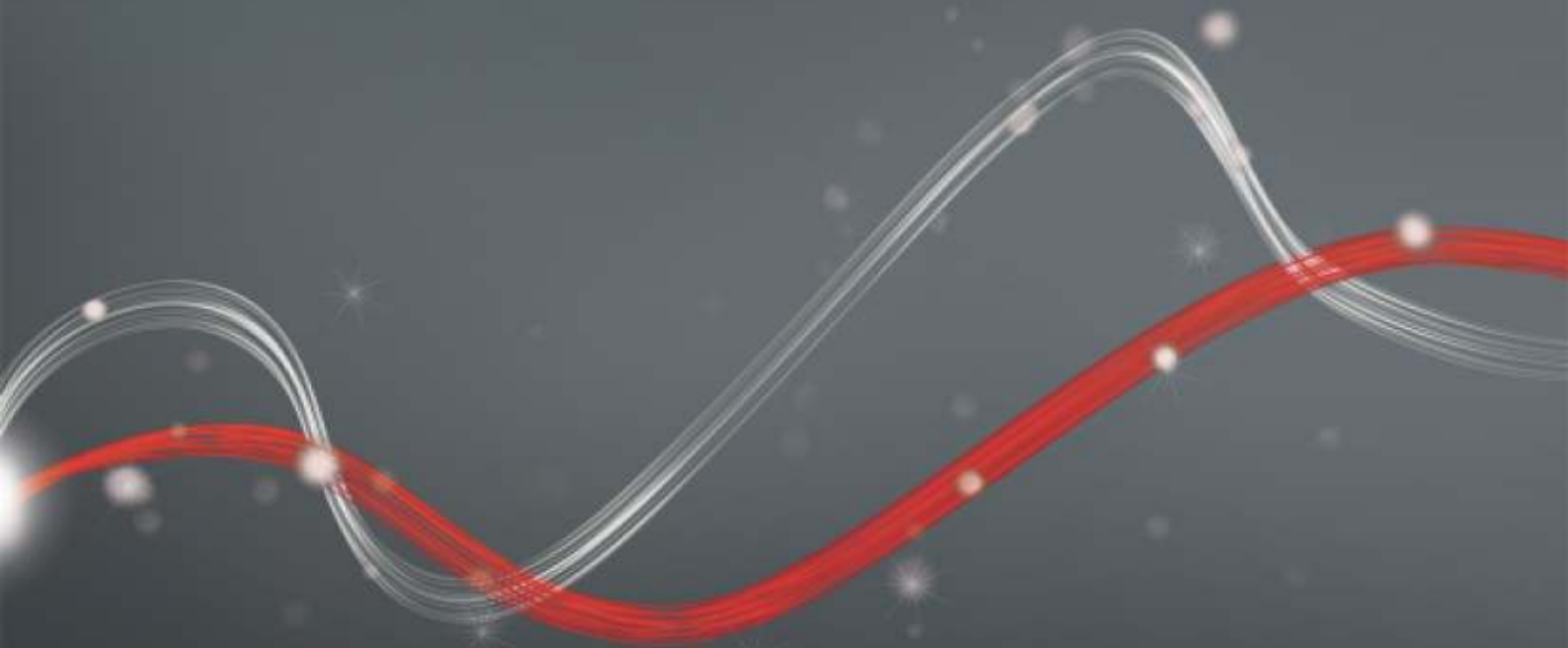

Be ahead



MICHELANGELO BT A





MICHELANGELO BT A



Automatic barriers - road barriers

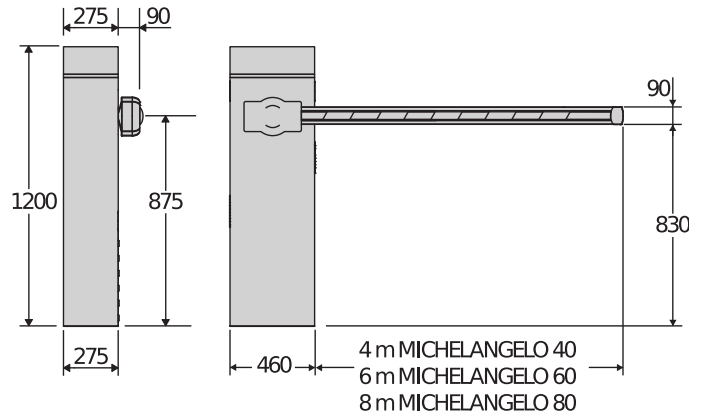
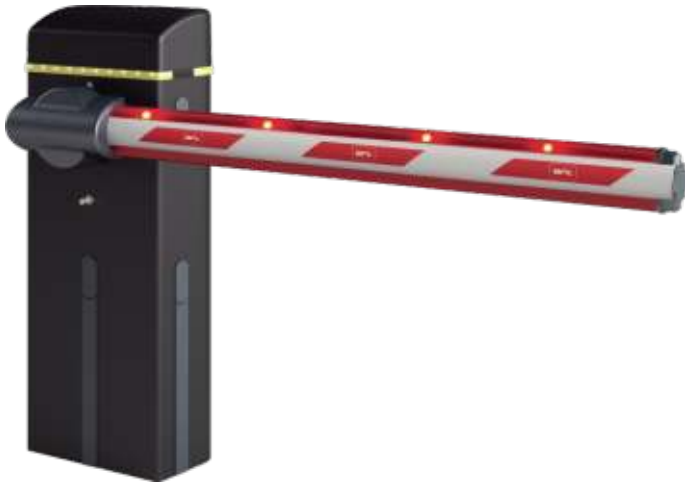

Range of barriers for very intensive use, for clear openings of up to 8 metres.
The wide range of accessories, incorporated flashing light and the arrangement for photocells make them ideal in any context

Relevant features



New control board Merak BM with U-Link connectivity slot, programming display and two-channel radio receiver incorporated. Mounted in the upper part of the barrier for an easier and convenient access.



IP54 protection level and new design.



Limit switch system with electronic adjustment that speeds up installation and ensures maximum precision in movement.





Automatic barriers - road barriers



Relevant features



Backup battery power supply system, installable on-board unit.





Automatic barriers - road barriers



MICHELANGELO BT A

Code	Name	Description	
P940076 00002	MICHELANGELO BT A 60 U	Barrier with 24 V power supply for useful passage up to 6 m and opening time 6 s. Impact reaction via Encoder. Control unit with ULink slot, display and receiver in head. RAL 7015 grey colour	U-Link
P940076 00102	MICHELANGELO BT A 60 U RAL	Barrier with 24 V power supply for useful passage up to 6 m and opening time 6 s. Impact reaction via Encoder. Control unit with ULink slot, display and receiver in head. RAL colour on request.	U-Link
P940076 00001	MICHELANGELO BT A 60 U 120	Control unit with ULink slot, display and receiver in head. RAL 7015 grey colour Barrier with 24 V power supply for useful passage up to 6 m and opening time 6 s. Impact reaction via Encoder.	U-Link
P940076 00101	MICHELANGELO BT A 60 U 120 RAL	Control unit with ULink slot, display and receiver in head. RAL colour on request Barrier with 24 V power supply for useful passage up to 6 m and opening time 6 s. Impact reaction via Encoder.	U-Link
P940077 00002	MICHELANGELO BT A 80 U	Barrier with 24 V power supply for useful passage up to 8 m and opening time 8 s. Impact reaction via Encoder. Control unit with ULink slot, display and receiver in head. RAL 7015 grey colour	U-Link
P940077 00102	MICHELANGELO BT A 80 U RAL	Control unit with ULink slot, display and receiver in head. RAL colour on request Barrier with 24 V power supply for useful passage up to 8 m and opening time 8 s. Impact reaction via Encoder.	U-Link
P940077 00001	MICHELANGELO BT A 80 U 120	Control unit with ULink slot, display and receiver in head. RAL 7015 grey colour Barrier with 24 V power supply for useful passage up to 8 m and opening time 8 s. Impact reaction via Encoder.	U-Link
P940077 00101	MICHELANGELO BT A 80 U 120 RAL	Control unit with ULink slot, display and receiver in head. RAL colour on request Barrier with 24 V power supply for useful passage up to 8 m and opening time 8 s. Impact reaction via Encoder.	U-Link

MERAK BMB: Incorporated control unit for one 24V operator for sliding gates

MERAK BMB - Built in



- Incorporated control unit for one 24V operator for sliding gates
- Card power supply: 230 V single-phase
- Main characteristics: removable terminal boards with the new colour standard, simplified programming with scenario display, integrated two-channel receiver, D-Track based antisquashing system and slowdown during opening or closing.

	MICHELANGELO BT A 60 U	MICHELANGELO BT A 60 U RAL	MICHELANGELO BT A 60 U 120	MICHELANGELO BT A 60 U 120 RAL	MICHELANGELO BT A 80 U	MICHELANGELO BT A 80 U RAL
Clear opening	6 m	6 m	6 m	6 m	8 m	8 m
Control unit	MERAK BM	MERAK BM	MERAK BM	MERAK BM	MERAK BM	MERAK BM
Motor power supply	24 V	24 V	24 V	24 V	24 V	24 V
Power consumption	300 W	300 W	300 W	300 W	300 W	300 W
Type of limit switch	Electronic	Electronic	Electronic	Electronic	Electronic	Electronic
Slowdown	Yes	Yes	Yes	Yes	Yes	Yes
Locking	Mechanical	Mechanical	Mechanical	Mechanical	Mechanical	Mechanical
Release	Key	Key	Key	Key	Key	Key
Impact reaction	Encoder	Encoder	Encoder	Encoder	Encoder	Encoder
Frequency of use	intensive	intensive	intensive	intensive	intensive	intensive
Protection rating	IP54	IP54	IP54	IP54	IP54	IP54
Environmental conditions	-20/(-40 with THERMO heater) ÷ 55 °C	-20/(-40 with THERMO heater) ÷ 55 °C	-20/(-40 with THERMO heater) ÷ 55 °C	-20/(-40 with THERMO heater) ÷ 55 °C	-20/(-40 with THERMO heater) ÷ 55 °C	-20/(-40 with THERMO heater) ÷ 55 °C



Automatic barriers - road barriers



	MICHELANGELO BT A 80 U 120	MICHELANGELO BT A 80 U 120 RAL
Clear opening	8 m	8 m
Control unit	MERAK BM	MERAK BM
Motor power supply	24 V	24 V
Power consumption	300 W	300 W
Type of limit switch	Electronic	Electronic
Slowdown	Yes	Yes
Locking	Mechanical	Mechanical
Release	Key	Key
Impact reaction	Encoder	Encoder
Frequency of use	intensive	intensive
Protection rating	IP54	IP54
Environmental conditions	-20/(-40 with THERMO heater) ÷ 55 °C	-20/(-40 with THERMO heater) ÷ 55 °C

RECOMMENDED ACCESSORIES

	D730964 - BM adjustable base plate for mod. MICHELANGELO - BM		N728022 - AQ6 Complete 6 m rectangular boom for MICHELANGELO
	N728026 - AT 704 Round boom ø 70 mm, length 4.3 m. for clear spaces up to 4 m ATT 704		N728030 - AT 706 Round boom diam. 70 mm length 6.35 m for MICHELANGELO. for openings up to 6 m
	N728028 - AT 502 Second part of telescopic round boom for MICHELANGELO, diam. 50 mm, length 2.6 m.		N728027 - AT 504 Second part of telescopic round boom for MICHELANGELO, diam. 50 mm, length 4.6 m.
	N999606 - OMEGA AQ 6 Accessories pack for AQ 6 boom		N999607 - OMEGA AT 70 Accessories pack for AT 704/706
	N999386 - ACC MCL ATT Accessories pack for ATT 704 / 706 ACC MCL ATT boom		P120072 - KIT ML MCL40 Spring kit for conversion from Michelangelo 60 to Michelangelo 40
	P120028 00001 - PCA N3 Top and bottom rubber cover profile for booms of 3 m max.		P120028 00002 - PCA N4 Top and bottom rubber cover profile for booms of 4 m max.



















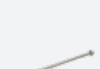

Automatic barriers - road barriers



RECOMMENDED ACCESSORIES

	P120028 00003 - PCA N5 Top and bottom rubber cover profile for booms of 5 m max.		P120028 00004 - PCA N6 Top and bottom rubber cover profile for booms of 6 m max.
	P120028 00005 - PCA N8 Top and bottom rubber cover profile for booms of 8 m max.		P120006 - MCL LAMPO KIT Integrated flashing light. The MCL CARD KIT is needed for operation
	P120009 - SCHEDA MCL KIT Control board for KIT MCL LIGHT and KIT MCL LAMPO		P120005 00001 - MCL LIGHT KIT Light kit (6 lights) for boom. For use in conjunction with PCA. The MCL CARD KIT is necessary for operation
	D573003 - SB Aluminium skirt for road barrier booms. Price per linear metre (Calculate length of useful passage minus 40cm)		D730088 - FAF Fixed rest fork for booms for cementing to ground.
	P125025 - FAF 2R		P120026 - ZFAF2 Additional anchor plates for cementing FAF2 forks to ground.
	P120023 - FAF 2 Rest fork for booms. For bolting to ground.		D940008 - GA AQ AT Movable support leg for AQ or AT booms (on MOOVI, MICHELANGELO and GIOTTO barriers) -
	D940009 - GAMA AQ AT Dampened movable support leg for AQ or AT booms (on MOOVI, MICHELANGELO and GIOTTO barriers) -		P120018 - THERMO Thermostatically controlled heating element for use of GIOTTO BT A, MOOVI, MICHELANGELO BT A barriers to ambient temperatures of -40°C
	N190104 - BIR C Rubber safety edge (H 30 mm), price per m		P125038 - MCL BT A BAT KIT Set of backup batteries for MICHELANGELO BT A barriers
	P111401 00001 - VENTIMIGLIA NS Infrared device for BIR C or BAR C safety edges (conforms to EN 12978 Standard)		P111001 00003 - RME 2 230 V dual channel metal object detector with installation base





Automatic barriers - road barriers



RECOMMENDED ACCESSORIES

	D110926 00001 - SPIRA 2X1 Magnetic loop 2 x 1 m			
--	---	--	--	--





Automatic barriers - road barriers



What is U-Link?

The technology that gives you more power

U-Link, Universal Link, is an exclusive BFT platform that can be used to create high-tech ecosystems. In Home Access Automation, it can be used to communicate with all home access automation devices of any brand. This saves you time and allows you to control everything easily and without any worries.

It is intuitive

Easy to install and to use

It is scalable

You can add as many devices as you want

It is flexible

It allows you to create groups of interconnected products

It is practical

Works with or without an internet connection

It is functional

Its settings can be controlled remotely using dedicated applications



Automatic barriers - road barriers



Everything on one screen: find out more about this amazing technology

A world-exclusive platform that **can be used to create high-tech ecosystems** offering a vast range of solutions for many different sectors.

This proprietary platform which is a key feature of BFT products, thanks to the B-EBA cards and the Clonix U-Link receiver, is suitable for any protocol or product for access automation (including BFT products non-BFT ones and older versions) and it can be used in a variety of different sectors. This means any device becomes a smart device which can be interconnected with other systems, using a language that is becoming universal.



U-Control HOME

U-Control HOME is the application that allows you to open the gate to your home and to remotely control BFT automations using your own smartphone. The iOS version can be used to automatically open the automation when you are close to it.



U-Base 2

A software package for installation, performing maintenance and identifying any faults in the U-Link compatible operators, easily and conveniently.



U-SDK

U-SDK is the application which allows BFT automations to be made compatible and easily integrated with a BMS network.



Clonix U-Link

Connect non-native U-Link and non-BFT products to U-Link systems.

Is it possible to connect non-native U-Link BFT operators or other brands of products to U-Link? Yes, thanks to the Clonix receivers. Accessories which accept no limits.



B-EBA

A direct link to your operators.

The B-EBA expansion cards make it possible to connect external devices such as PCs, smartphones and tablets to a BFT operator and a Clonix receiver or to connect multiple BFT products in a U-Link network. These accessories integrate with U-Link technology and with Bluetooth, Wifi, Z-Wave and TCP/IP protocols as well as with the RS485 serial interface. A device that demonstrates exactly what BFT means by interconnectivity.

