



Be ahead



# E5 BT A





## Electromechanical automation systems for swing gates



Empowered by  
**U-LINK**

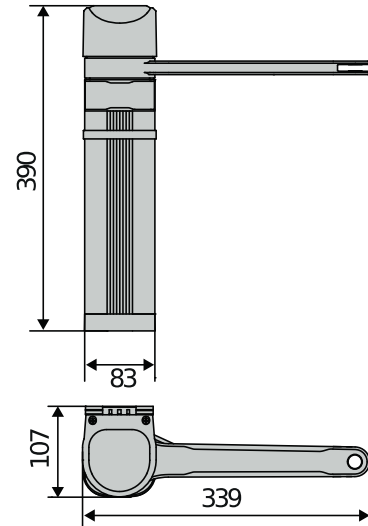

24V reversible electromechanical operator for swing gate panels for pedestrian and vehicular access, for use in homes, apartment buildings and commercial areas. Its small size means it can be installed on small pillars and columns (minimum width required 8cm). The slide arm option means constraints such as walls and obstacles close to the operator can be overcome. The limit switch function is regulated by the absolute encoder. The safety of the operator is guaranteed thanks to the D-track system which precisely determines the position and force with which the gate moves, using the friction inside the operator and the new articulated and slide arms with anti-shear design.





## Electromechanical automation systems for swing gates



### E5 BT A

Code	Name		Description	
P930027 00003	E5 BT A12		Reversible compact pedestrian electromechanical operator of small size that can be installed on pillars or columns only 80mm wide Application for pedestrian gates up to 1.2m wide and up to 80kg in weight Closes in 6.5s (ideal installation conditions)	
P930027 00001	E5 BT A18		Reversible compact vehicular electromechanical operator of small size that can be installed on pillars or columns only 80mm wide Application for pedestrian gates up to 1.8m wide and up to 100kg in weight	

### THALIA: Control panel with display for one or two 24V electromechanical operators for swing gates



#### D113745 00002 - THALIA - Recommended



- Application: control panel with display for one or two 24V electromechanical operators for swing gates
- Card power supply: 230 V single-phase
- Operators power supply: 24Vdc 180W max each operator
- Main features: new standard colour removable terminal blocks, simplified scenario-based programming with display and integrated dual-channel receiver, D-Track anti-crushing system, slowdown during opening and closing and electronic self-learning.
- Main functions: automatic re-closing, fast closing, partial opening, deadman feature
- Compatibility: LIBRA C MA, LIBRA, LIBRA R, LIBRA MA R

	E5 BT A12	E5 BT A18
Control unit	THALIA	THALIA
Board power supply	230 V	230 V
Motor voltage	24 V	24 V
Max. weight of door/gate wing	80 kg	100 kg
Power consumption	40 W	40 W
Max. width of door/gate wing	1,20 m	1,80 m
Cycle time	6,50 s	14 s
Type of limit switch	Absolute encoder	Absolute encoder
Release	Reversible	Reversible
Impact reaction	D-Track	D-Track
Frequency of use	Residential	Semi intensive
Degree of protection (IP)	IP44	IP44
Environmental conditions	-10 ÷ 60 °C	-10 ÷ 60 °C

## RECOMMENDED ACCESSORIES

	D113747 00002 - <b>THALIA P</b>		N734921 - <b>LBA</b>
	Control panel for one or two 24V electromechanical and hydraulic operators for swing gates with electric lock management, for highly complex systems		Lever for articulated arm, E5 BT A12, E5 BT A18











## Electromechanical automation systems for swing gates



### RECOMMENDED ACCESSORIES

 <b>new</b> N735057 - <b>LS12</b>	Short pedestrian slide lever for E5 BT A12	 <b>new</b> N735058 - <b>LS18</b>	Long slide lever for E5 BT A18
 <b>new</b> D114093 00003 - <b>RADIUS LED BT A R1</b>	Flashing light with incorporated antenna for motors with power supply 24 V.	 <b>new</b> D114168 00003 - <b>RADIUS LED BT A R1 W</b>	Flashing light with built-in antenna for motors with a 24 V power supply. White flashing light.
 <b>new</b> D114094 00003 - <b>RADIUS LED BT A R0</b>	Flashing light without incorporated antenna for motors with power supply 24 V.	 <b>new</b> P111782 - <b>COMPACTA A20-180</b>	Pair of photocells adjustable 180 ° horizontally. Range 20m. Power supply 12 – 33Vac / 15 – 35Vdc





Electromechanical automation systems for swing gates



# What is U-Link?

The technology that gives you more power

U-Link, Universal Link, is an exclusive BFT platform that can be used to create high-tech ecosystems. In Home Access Automation, it can be used to communicate with all home access automation devices of any brand. This saves you time and allows you to control everything easily and without any worries.

## It is intuitive

Easy to install and to use

## It is scalable

You can add as many devices as you want

## It is flexible

It allows you to create groups of interconnected products

## It is practical

Works with or without an internet connection

## It is functional

Its settings can be controlled remotely using dedicated applications



## Electromechanical automation systems for swing gates



# Everything on one screen: find out more about this amazing technology

A world-exclusive platform that **can be used to create high-tech ecosystems** offering a vast range of solutions for many different sectors.

This proprietary platform which is a key feature of BFT products, thanks to the B-EBA cards and the Clonix U-Link receiver, is suitable for any protocol or product for access automation (including BFT products non-BFT ones and older versions) and it can be used in a variety of different sectors. This means any device becomes a smart device which can be interconnected with other systems, using a language that is becoming universal.



### U-Control HOME

U-Control HOME is the application that allows you to open the gate to your home and to remotely control BFT automations using your own smartphone. The iOS version can be used to automatically open the automation when you are close to it.



### U-Base 2

A software package for installation, performing maintenance and identifying any faults in the U-Link compatible operators, easily and conveniently.



### U-SDK

U-SDK is the application which allows BFT automations to be made compatible and easily integrated with a BMS network.



Clonix U-Link  
Connect non-native U-Link and non-BFT products to U-Link systems.

Is it possible to connect non-native U-Link BFT operators or other brands of products to U-Link? Yes, thanks to the Clonix receivers. Accessories which accept no limits.



B-EBA  
A direct link to your operators.

The B-EBA expansion cards make it possible to connect external devices such as PCs, smartphones and tablets to a BFT operator and a Clonix receiver or to connect multiple BFT products in a U-Link network. These accessories integrate with U-Link technology and with Bluetooth, Wifi, Z-Wave and TCP/IP protocols as well as with the RS485 serial interface. A device that demonstrates exactly what BFT means by interconnectivity.

